

FTU *boghandel*

Nyhedsbrev 15

Februar 2008



FTU Boghandel
Halmstadgade 6, 8200 Århus N
Tlf: 86 10 03 38 / Mail: ftu@ats.dk / Inet: www.ftu.dk

Hvem er FTU Boghandel?

FTU Boghandel er en specialboghandel indenfor teknik, edb, økonomi og business.

FTU Boghandel er desuden:
Microsoft Press Knowledge Center
&
Cisco Press Preferred Supplier.

FTU Afdelinger

Hovedafdeling

FTU Boghandel
Halmstadgade 6, 8200
Århus N.

Tlf. 86 10 03 38
Fax. 8937 3555
Mail: ftu@ats.dk

Åbningstider
Mandag - Torsdag: 8-16
Fredag 8-14

Afdeling Sønderhøj

FTU Boghandel
Sønderhøj 30,
8260 Viby J

Tlf: 89 36 33 60

Åbningstider
Mandag til Fredag. 9-14

Bestillingsmåder:

Du kan bestille bøger pr. brev, telefon, e-mail eller på www.ftu.dk og selvfølgelig i butikken.

Priser:

Alle priser er i danske kroner inkl. moms. Priserne er faste i tilbudsperioden, dog tages der forbehold for prisændringer og trykfejl.

Betaling:

14 dage netto fra fakturadato, med mindre andet aftales.



Ved køb af

4 FORSKELLIGE CISCO PRESS BØGER

Får du

50% RABAT

Tilbuddet gælder indtil

31. MARTS

Læs mere på www.ftu.dk
Eller kontakt os på telefon, mail eller i butikken



FTU Boghandel, Halmstadgade 6, 8200 Århus N
Tlf: 86 10 03 38

Mail: ftu@ats.dk

CCNA Discovery



A new type of book will support the CCNA Discovery courses.

The new Cisco Press Learning Guides will complement and supplement the CCNA Discovery courses by combining the textbook with the labs in one book per course.

The books focus on readability, study aids, pedagogy, and practice. Each of the books provides tutorial content that reinforces and supplements the corresponding online curriculum.

Each book will also contain the hands-on labs for the course plus additional labs from the Cisco Press authors to strengthen the learners' understanding of the course materials.

These books are 8.5" x 11" paperbacks with CD-ROM.

CCNA Discovery (Version 4.0)

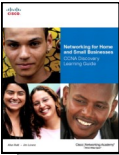

Networking for Home and Small Business CCNA Discovery Learning Guide

ISBN 9781587132094
Available October 2007

Pris: 625,00 Kr.

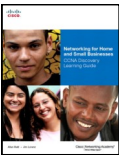

Working at a Small-to-Medium Business or ISP CCNA Discovery Learning Guide

ISBN 9781587132100
Available December 2007

Pris: 625,00 Kr.

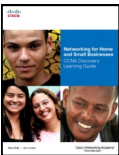

Introducing Routing and Switching in the Enterprise CCNA Discovery Learning Guide

ISBN 9781587132117
Available Early 2008

Pris: 509,00 Kr.



Designing and Supporting Computer Network CCNA Discovery Learning Guide

ISBN 9781587132124
Available Early 2008

Pris: 567,00 Kr.

CCNA Exploration

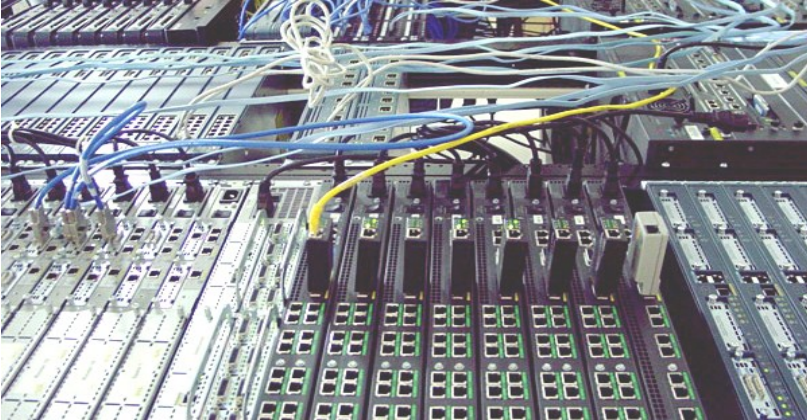

Two types of books will directly support each course within the CCNA Exploration curriculum. The two book formats support each course with flexible learning and study tools.

Companion Guides are portable desk references of the Cisco Networking Academy Program course material that students can use anytime, anywhere. Companion Guides are designed to reinforce online course material, helping students focus on important concepts and organize their study time for quizzes and exams.

Labs and Study Guides, a format introduced in 2006, provides students with a convenient, complete collection of course lab exercises PLUS supplemental exercises for each of the Networking Academy courses. The Study Guide sections provide learning exercises. The course labs are designed to give students hands-on experience in a particular concept or technology. The supplemental labs from the authors provide additional hands-on practice as well as more advanced challenges.

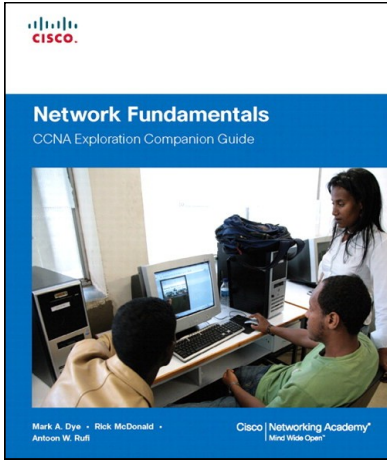

Network Fundamentals

Mark Dye

"Network Fundamentals CCNA Exploration Companion Guide" is the official supplemental textbook for this CCNA Exploration course in the Cisco Networking Academy Program. Completely revised to the new curriculum with new examples and explanations, this textbook includes original material developed by the authors, yet it fully aligns with the CCNA curriculum.

Labs & Study Guide Available

Published: Oct 2007
ISBN: 9781587132087
560 Pages
Pris: 403,00 Kr.

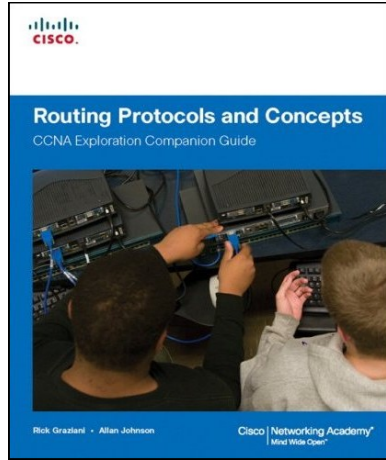

Routing Protocols and Concepts

Rick Graziani

The new edition incorporates recently improved features to aid instructors and enhance student comprehension. Chapters align with course modules in both name and number, and chapter objectives are stated as questions to encourage students to think about and find answers as they read chapters.

Labs & Study Guide Available

Published: Oct 2007
ISBN: 9781587132063
640 Pages
Pris: 403,00 Kr.

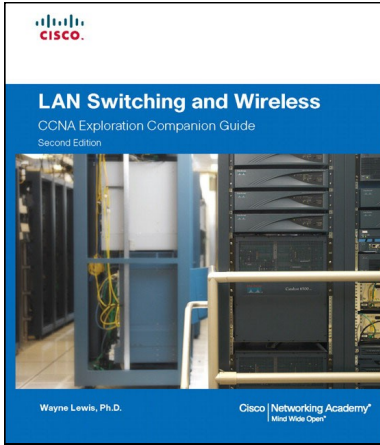

LAN Switching and Wireless

Wayne Lewis

Written and edited by Networking Academy instructors, is designed as a portable desk reference to use anytime, anywhere.

The book's features reinforce the material in the course to help you focus on important concepts and organize your study time for exams.

Labs & Study Guide Available

Published: May 2008
ISBN: 9781587132070
600 Pages
Pris: 365,00 Kr.



Accessing the WAN

Bob Vachon

Written by experienced instructors who present material using their own voices and some of their own examples, this new edition is designed to enhance student understanding of the material. This edition also incorporates recently improved features to aid instructors and enhance student comprehension.

abs & Study Guide Available

Published: May 2008
ISBN: 9781587132056
600 Pages
Pris: 365,00 Kr.

THE NEW CCNP Portable Command Guides

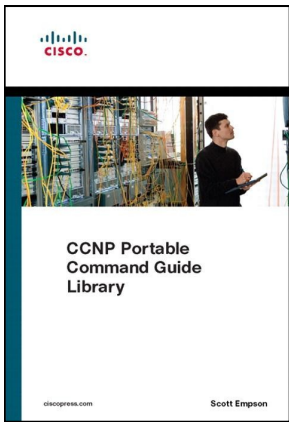

CCNP Portable Command Guide Library

The Complete package of the 4 CCNP Portable Command Guides.

Author: Scott Empson

Published: Dec 2007

ISBN: 9781587201875

Pris: 894,00 Kr.

OBS: IKKE inkluderet i Forårstilbud

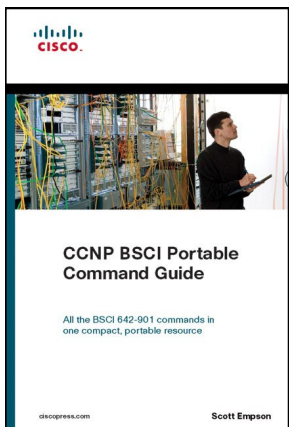

CCNP BSCI

- Portable Command Guide

Author: Scott Empson

Published: May 2007

ISBN: 9781587201899

Pages: 173

Pris: 264,00 Kr.

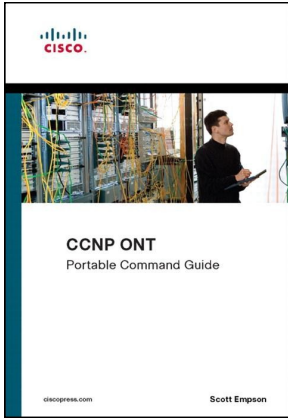

CCNP ONT

- Portable Command Guide

Author: Scott Empson

Published: Dec 2007

ISBN: 9781587201851

Pages: 250

Pris: 302,00 Kr.

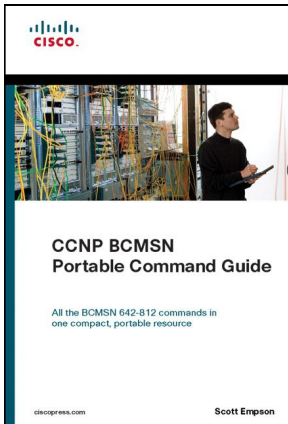

CCNP BCMSN

- Portable Command Guide

Author: Scott Empson

Published: June 2007

ISBN: 9781587201882

Pages: 151

Pris: 312,00 Kr.

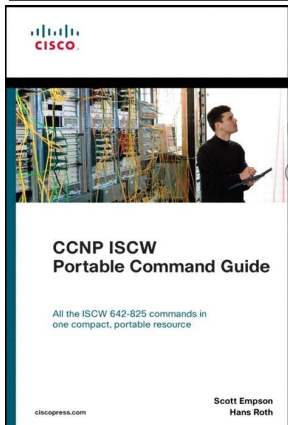

CCNP ISCW

- Portable Command Guide

Author: Scott Empson

Published: November 2007

ISBN: 9781587201868

Pages: 250

Pris: 312,00 Kr.

Oversigt over CISCO Certificeringer

Materiale til alle eksamener kan erhverves ved FTU Boghandel.

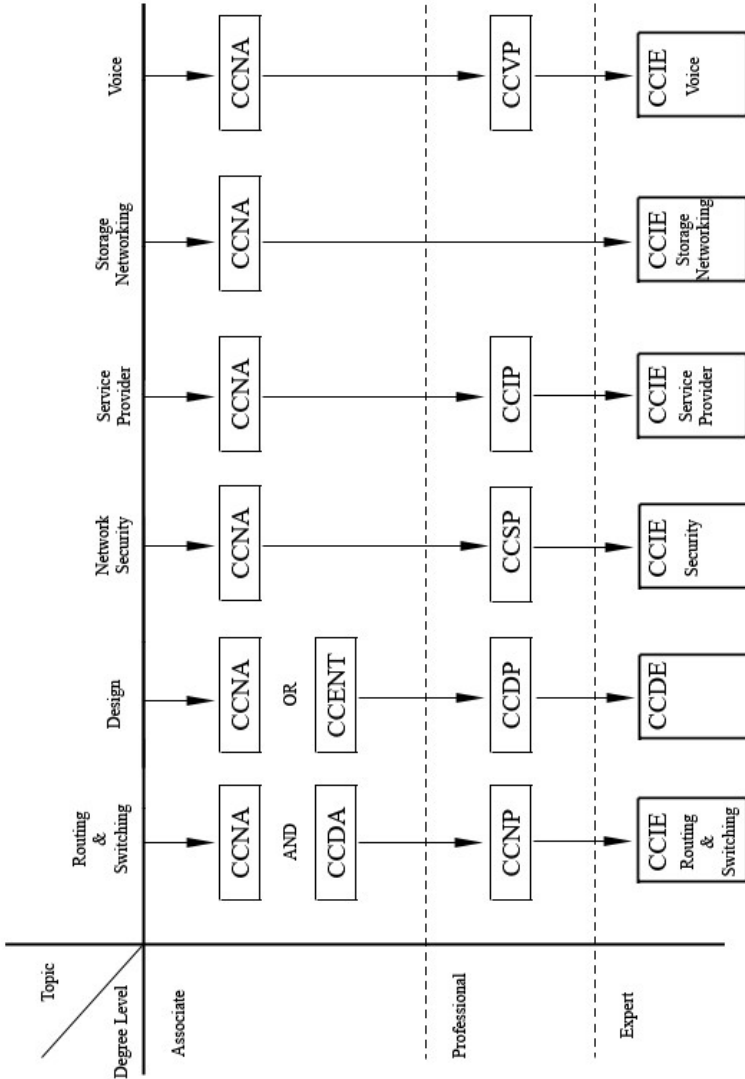

FTU FORÅRSTILBUD **FTU**
boghandel *boghandel*

Ved køb af

4 FORSKELLIGE CISCO PRESS BØGER

Får du

50% RABAT

Tilbuddet gælder indtil

31. MARTS

Læs mere på www.ftu.dk

Eller kontakt os på telefon, mail eller i butikken

FTU FORÅRSTILBUD **FTU**
boghandel *boghandel*

FTU Boghandel, Halmstadgade 6, 8200 Århus N

Tlf: 86 10 03 38

Mail: ftu@ats.dk